

Scotland's Rural College

Determination of the absolute accuracy of UK chamber facilities used in measuring methane emissions from livestock

Gardiner, TD; Coleman, MD; Innocenti, F; Tompkins, J; Connor, A; Garnsworthy, PC; Moorby, JM; Reynolds, CK; Waterhouse, A; Wills, D

Published in:
Measurement

DOI:
[10.1016/j.measurement.2015.02.029](https://doi.org/10.1016/j.measurement.2015.02.029)

Print publication: 01/01/2015

Document Version
Peer reviewed version

[Link to publication](#)

Citation for published version (APA):

Gardiner, TD., Coleman, MD., Innocenti, F., Tompkins, J., Connor, A., Garnsworthy, PC., Moorby, JM., Reynolds, CK., Waterhouse, A., & Wills, D. (2015). Determination of the absolute accuracy of UK chamber facilities used in measuring methane emissions from livestock. *Measurement*, 66, 272 - 279. <https://doi.org/10.1016/j.measurement.2015.02.029>

General rights

Copyright and moral rights for the publications made accessible in the public portal are retained by the authors and/or other copyright owners and it is a condition of accessing publications that users recognise and abide by the legal requirements associated with these rights.

- Users may download and print one copy of any publication from the public portal for the purpose of private study or research.
- You may not further distribute the material or use it for any profit-making activity or commercial gain
- You may freely distribute the URL identifying the publication in the public portal ?

Take down policy

If you believe that this document breaches copyright please contact us providing details, and we will remove access to the work immediately and investigate your claim.

Determination of the Absolute Accuracy of UK Chamber Facilities used in Measuring Methane Emissions from Livestock

T.D. Gardiner¹, M.D. Coleman¹, F. Innocenti¹, J. Tompkins¹, A. Connor¹, P.C. Garnsworthy²,
J. M. Moorby³, C.K. Reynolds⁴, A. Waterhouse⁵, D. Wills⁶

¹National Physical Laboratory, Hampton Road, Teddington, Middlesex, TW11 0LW, UK

²The University of Nottingham, School of Biosciences, Sutton Bonington Campus,
Loughborough LE12 5RD, UK.

³Institute of Biological, Environmental and Rural Science, Aberystwyth University,
Gogerddan, Aberystwyth, SY23 4AD, UK

⁴Centre for Dairy Research, School of Agriculture, Policy, and Development, University of
Reading, PO Box 237, Earley Gate, Reading, RG6 6AR, UK

⁵Future Farming Systems, Scotland's Rural College, West Mains Road, Edinburgh, EH9 3JG,
UK

⁶Agri-Food and Biosciences Institute, AFBI Hillsborough, Large park, Hillsborough, Co.
Down, BT26 6DR, UK

*Corresponding author. E-mail: tom.gardiner@npl.co.uk, Tel.: +44 (0)208 943 7143

Abstract

Respiration chambers are one of the primary sources of data on methane emissions from livestock. This paper describes the results from a coordinated set of chamber validation experiments which establishes the absolute accuracy of the methane emission rates measured by the chambers, and for the first time provides metrological traceability to international standards, assesses the impact of both analyser and chamber response times on measurement uncertainty and establishes direct comparability between measurements made across different

facilities with a wide range of chamber designs. As a result of the validation exercise the estimated combined uncertainty associated with the overall capability across all facilities reduced from 25.7% ($k=2$, 95% confidence) before the validation to 2.1% ($k=2$, 95% confidence) when the validation results are applied to the facilities' data.

keywords: respiration chambers, methane emissions, livestock emissions, calibration, traceability

1. Introduction

Methane is a greenhouse gas (GHG) with a global warming potential 33 times that of carbon dioxide^[1]. Agriculture is a significant contributor to global methane emissions as evidenced by the 2011 European Union inventory detailing that 50% of all methane emissions were attributable to the agricultural sector^[2]. Currently in the UK livestock emissions (contributing ~85% of methane emissions from agriculture) are calculated using the Tier 1 approach^[3] under the United Nations Framework Convention on Climate Change (UNFCCC). The Tier 1 approach is based on using emission factors (EFs) for different livestock categories and associated manures, i.e. no account is made with respect to farm activity or mitigation effort^[3]. Consequently, the UK Government's Department for the Environment and Rural Affairs (DEFRA) have commissioned a programme of research to facilitate movement to a Tier 2 or 3 approach under UNFCCC - the Agricultural Greenhouse Gas Inventory Research Platform^[4]. A key part of this research is work to underpin national measurement infrastructure to ensure that various UK facilities used for measuring livestock methane emissions are producing comparable data that is traceable to the international system of units and has quantified uncertainties, and this is reported here.

A generally accepted method for determining emissions is the respiration chamber where the animal is placed in the chamber with a controlled throughput of ambient air^[5]. Measuring the concentration difference between the outlet and inlet combined with the flow rate gives the total emitted methane rate. Historically such chambers were used to estimate heat production for measurements of energy metabolism^[6-9], which required precise and accurate measurements of oxygen consumption and carbon dioxide and methane production by animals housed in the chamber. However, due to the reasons outlined above the focus has now shifted towards using chambers to determine the impact of animal husbandry practises on methane emissions, often with simpler designs^[10-12].

To truly understand the accuracy of any method and to establish the comparability between different measurement systems there must be comparison to an internationally accepted reference point. Historically, the accuracy of chamber measurements has been based on calibration of flow meters and analyser performance^[8] and measurement of emissions obtained during a weighed release of the target gas into the chambers. McLean and Tobin^[8] give an extensive review of recommended procedures at that time and Cammel et al.^[7] summarise results for a number of published respiration chamber calibrations. More recently Hellwing et al.^[13] report on the calibration of a simple respiration chamber for cattle. However, the work reported here is, to our knowledge, the first to provide metrological traceability to international standards, assess the impact of both analyser and chamber response times on measurement uncertainty, and establish direct comparability between measurements made across different facilities with a wide range of chamber designs. In addition, the combination of direct analyser calibration and controlled methane releases at different locations enable the performance of the main elements of the experimental system

to be assessed independently and their relative contribution to the combined system uncertainty determined.

The aim of this work was to establish the performance and comparability of different UK chamber facilities. This paper describes the results from a coordinated set of chamber validation experiments conducted at 6 chamber facilities at 5 leading agricultural research centres around the UK.

2. Materials and methods

2.1 Chamber Designs

All of the test chambers across the six facilities were based on the same basic design principle (Fig. 1), although there were marked differences in terms of size, flow conditions and age across the different facilities. In all cases, ambient air is drawn into the chamber and mixes with the emissions from the test subject before being vented to atmosphere via an extract duct. A flow meter (hot wire or vane based) is positioned in the extract duct to determine the chamber flow rate whilst an interfaced gas line is used to pump a sample of the extract gas through an analyser to determine the methane concentration. Combining the flow rate and concentration measurements allows the methane emission rate to be calculated using in-house methodologies. The details of the chamber designs and the differences between them are beyond the scope of this paper and are only discussed if relevant to the reported observations.

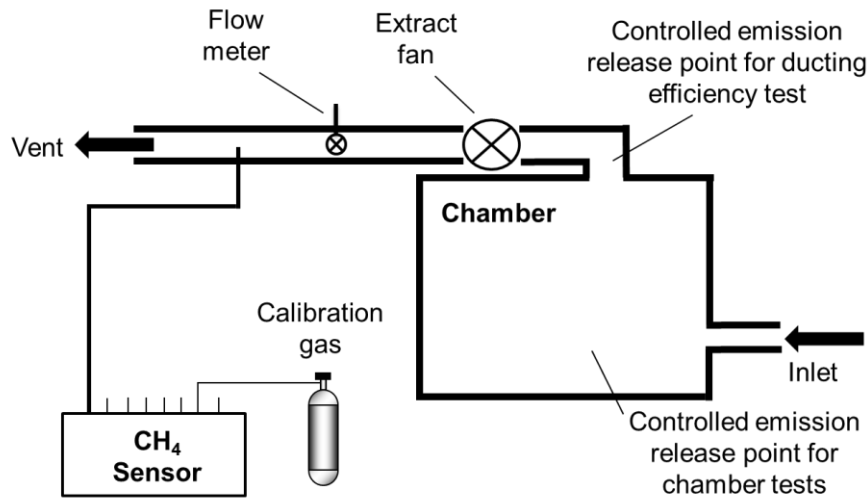

Figure 1 Schematic of operational principle of livestock respiration chambers across six UK research facilities. Calibration gas and release points only included during National Physical Laboratory testing of facilities.

Incumbent facility staff were present in order to operate chambers, explain configuration differences and calculate the measured emission rates using their normal methods. However, all experiments were carried out by independent researchers from the National Physical Laboratory.

2.2 Calibration System Design

A calibrated reference source of methane emission was produced by dynamically mixing ultra-high purity methane (BOC Gases, $\geq 99.9995\%$ purity) and nitrogen (Air Products BIP grade, < 50 ppbv methane equivalents of hydrocarbon contamination) using an bespoke blender based on Aera FC-7000 series mass flow controllers (MFCs). The use of MFCs gives active control of the emitted flows, enabling stable flows to be maintained throughout the measurement periods. The blender system consisted of two pairs of MFCs. Each pair consisted of a MFC delivering methane and the other delivering nitrogen, with one pair set up

for chambers usually measuring sheep and the other for chambers usually measuring cattle. The flows from the MFC pairs were set to provide an approximately constant total flow of gas independent of the amount of methane being delivered. Rather than relying on the manufacturers specifications, each MFC was directly calibrated for flow rate of the relevant gas via weight loss using NPL's gravimetric gas standard preparation facilities, which are recognised by the International Committee for Weights and Measures^[14] as providing gaseous reference materials for calibration of UK laboratories to internationally validated levels of uncertainty^[15]. This enabled mass emissions with an uncertainty of 1.0% (coverage factor of $k = 2$, 95% level of confidence – written as 'k=2, 95% confidence' hereafter) to be generated. The pair set up for sheep chambers were typically used to deliver 0.4 mg/s (~0.035 l/min) of methane in a total flow of ~1 l/min, while the pair set up for cattle chambers were typically used to deliver 6.0 mg/s (~0.5 l/min) of methane in a total flow of 3 l/min. The outputs from the MFCs were combined using ¼" stainless steel tubing and Swagelok fittings. The blender system was leak tested with soap solution prior to use and the line was isolated overnight and demonstrated to maintain pressure over a 12 hour period with no measureable losses.

The source was delivered from the blender via a bespoke sample line and dispersion system into the chambers. The sample line was a single continuous length of ¼" perfluoroalkoxy (PFA) tubing with stainless steel fittings from Swagelok. The dispersion system consisted of a series of ¼" Swagelok T-pieces which spread the emission over a volume of ~4300 cm³ through 18 separate outputs, without putting a restriction on the output flow.

2.3 Facility Testing Methodology

Each facility consisted of several chambers, since in normal operation a group of test animals is passed through all the chambers in order to determine an emission rate of statistical significance. To facilitate evaluation, and help identify the sources of measurement uncertainty, the chambers were considered as having three principal components: the methane analyser; the ducting and flow system extracting gas out of the chamber; and the chamber itself.

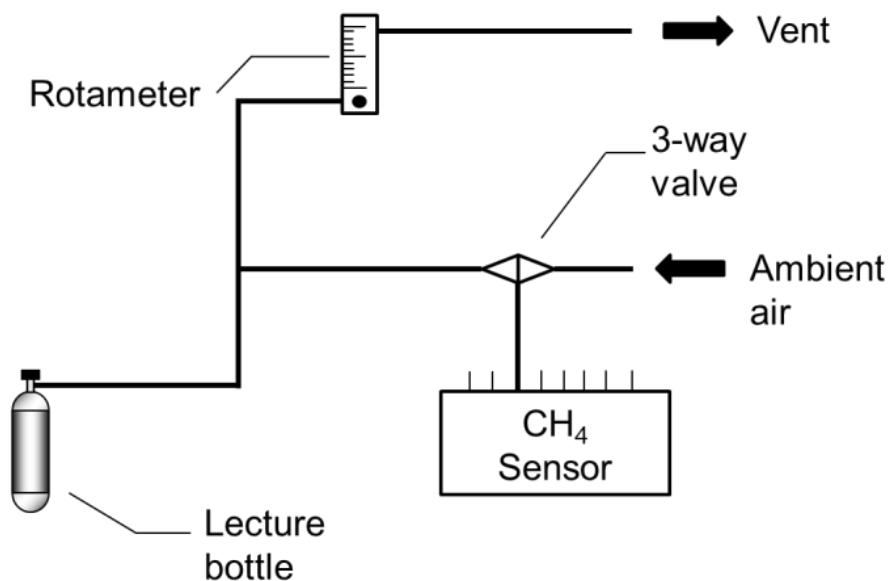

Figure 2 Schematic of gas delivery system used to evaluate the response of the methane analysers. The 3-way valve allows switching between ambient and calibration gas, and the rotameter is used to ensure a positive by-pass flow to the vent.

All six facilities used infrared gas filter correlation analysers to measure the methane concentrations in the chambers. The gas correlation method has generally high specificity to the target gas and it is therefore assumed that cross-interference to other species will not be a significant issue for these measurements. The analyser responses were tested by applying a series of NPL prepared standards of methane in synthetic air (i.e. N₂ and O₂ only) designed to

span the concentration range typically seen by the particular analyser being tested. The standards were introduced to one of the analyser sample ports using the by-pass flow arrangement shown schematically in Figure 2. This arrangement ensured the analyser was able to take the required sample volume without over-pressuring the input line, together with the ability to rapidly switch between ambient air and calibration gas without disrupting the sample flow. A total of eight calibration standards were prepared specifically for these tests to cover the complete range seen by the different facilities, with methane concentrations from 10 $\mu\text{mol/mol}$ to 500 $\mu\text{mol/mol}$. These standards were prepared in NPL's gravimetric gas standard facilities and traceably certified to an uncertainty of 0.5 % ($k=2$, 95% confidence). Each facility's analyser was tested for accuracy, linearity, response time, and plateau stability. Carrying out a linear regression between the analyser readings and reference values provided a linear calibration function for the analyser. The response time was defined as the time taken to reach 90% of the final stable plateau reading (T_{90}) when the sample was switched from ambient air to calibration gas, in accordance with EN 15267-3^[16]. The plateau stability was taken as the 1σ noise level on the stable plateau reading (as a percentage of the plateau value), measured over a typical period of around 1 minute. Note that each facility had a data logging system implemented to record the analyser readings, and this was often on a relatively slow timescale compared to individual analyser readings. Therefore manual readings of the analyser were taken every 10 seconds to provide response time data.

The ducting efficiency was tested by directly releasing a reference emission of methane inside the ducting close to the interface with the chamber. The usual calculations of chamber emission rate could then be carried out by the facility operator and compared to the reference emission rate from the calibrated methane source, giving a calibration measurement that was not influenced by the chamber itself. If this calculation is carried out after applying the

analyser calibration function to the methane concentration readings then the efficiency of the ducting can be determined in isolation. Any deviation from unity could highlight issues with the accuracy of the flow measurement combined with any losses or sampling issues in the duct itself. Time restrictions meant that it was not possible to carry out ducting efficiency measurements for every chamber at every facility.

The final stage of each experiment was to release a reference emission rate of methane through the diffuser in the chambers, at a typical animal head position, and compare this to the measured emission rate.. This comparison provided a direct calibration of the overall chamber emission measurement and enabled the combined system efficiency to be determined. It differs from the ducting efficiency measurement by including any losses from the chamber itself and any additional sampling issues due to the flow mixing behaviour within the chamber. By applying the previously calculated analyser calibration function and ducting efficiency to the readings it also allowed the chamber capture efficiency to be evaluated in isolation, i.e. what fraction of the methane emitted into the chamber was captured by the sampling system.

As described above, the experiments with the reference emission source enabled three different efficiency parameters to be evaluated :

- The ducting efficiency – given by the ratio of the measured rate (having corrected for the sensor calibration) to the rate emitted by the calibration source, when the source was placed directly in the ducting.
- The chamber capture efficiency – given by the ratio of the measured rate (having corrected for the sensor calibration and ducting efficiency) to the reference rate emitted by the calibration source, when the source was placed in the chamber.

- The overall system efficiency – given by the ratio of the measured rate (with no corrections) to the reference rate emitted by the calibration source, when the source was placed in the chamber.

In each case, the efficiency gives a measure of the fraction of the calibration source that is measured by that element of the facility, so an efficiency of less than one indicates a lower measured reading than it should be. In order to correct a result to the calibration reference value the result should be divided by the relevant efficiency.

Since the calibrated methane source could be used to apply a step change to the methane levels inside a chamber, the results from the chamber measurements were also used to determine the response times and plateau stabilities of the chambers themselves. The chamber plateau stabilities were typically measured over a period of around 30 min. Another parameter derived for the chambers was the effective precision for the determination of the average emission over a full day (24 h) of measurements. The 24 h precision value is derived from the expected reduction in the measurement noise that results from averaging N independent measurements, given by the $S/N^{1/2}$ where S is the plateau stability and N is the number of independent measurements in a 24 h period. The time between independent measurements is taken as the $(3 \times T_{90})$ period for each chamber. Chamber tests were carried out for a range of reference emission rates, enabling the full system linearity to be assessed.

3. Results and discussion

3.1 Calibration of Methane Analysers

Figure 3 shows the typical response time of one of the methane analysers used in a chamber facility when a methane calibration standard is sampled. In this case the analyser reached 90% of the stable plateau reading in 37.1 s.

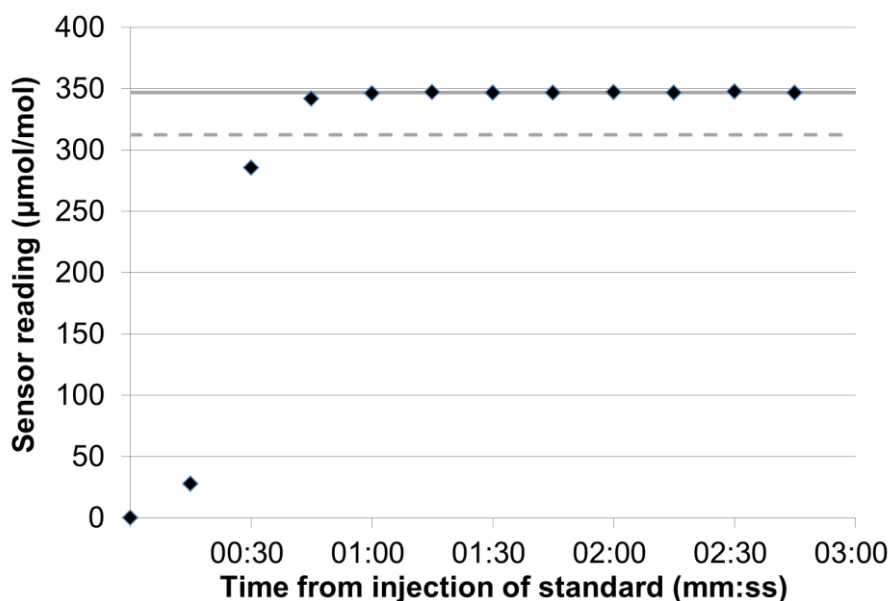

Figure 3 Response of a methane analyser to injection of calibration standard of methane. Black diamonds show the analyser's response with time measured every 10 s, the solid line shows the plateau reading level, and the dotted line shows the 90% value of plateau reading.

Table 1 summarises the results of the methane analyser calibration experiments for all 6 (anonymised) facilities. The test span value gives the range of concentrations over which the analyser was calibrated, while the calibration factor gives the adjustment factor that has to be applied to the analyser reading together with the related ($k=2$, 95% confidence) uncertainty. The plateau stability indicates the 1σ noise level on the stable plateau reading (as a percentage of the plateau value), and the analyser response times are given by the T_{90} values.

Finally the linearity of the analyser response over the measurement range is given by the R^2 value of a linear regression fit to the calibration data.

Facility	Test Span ($\mu\text{mol/mol}$)	Calibration Factor	Plateau Stability	T_{90} Response (s)	Linearity (R^2)
A	500	0.987 +/- 0.018	0.11%	37.1	0.9999
B	100	1.040 +/- 0.040	0.93%	33.7	0.9999
C	50	0.978 +/- 0.166	0.34%	38.1	0.9999
D	100	1.086 +/- 0.150	0.63%	35.4	0.9965
E	200	1.008 +/- 0.048	0.57%	28.9	0.9995
F	500	0.995 +/- 0.026	1.01%	25.6	0.9999

Table 1 Summary of Analyser Calibration Results, showing for each facility analyser assessed : the span of concentrations covered, the calibration factor and its uncertainty at the span value, the variability once a stable reading is reached, the T_{90} response time and the R^2 linearity of response across the calibrated range.

All analysers showed good linearity over the measurement range with R^2 greater than 0.996 in all cases, and high levels of accuracy with all responses equivalent to the reference value at the 95% confidence uncertainty level. The plateau stabilities showed a general level of instrument precision of 1% or better, with reasonably consistent response times varying between 25 s and 39 s.

These results confirm the general suitability of the methane analysers in the ranges used for each chamber facility. However, there were a number of specific issues that arose from the analyser tests that could have implications for overall facility operations, and these are summarised below:

- All groups performed regular span checks of the analyser using a reference gas to ensure the long-term stability of the measurements, but it is important that the actual reference gas used provides a span value close to the typical measurement values to ensure the analyser is checked at similar levels to its usual operation. Although sensor linearity has been established at the time of these measurements, it cannot be guaranteed that this will be maintained in the long term. By carrying out span checks near the typical measurement values the uncertainty that arises from any long-term adjustments to the sensor response is minimised as the span result would not need to be extrapolated over a wide range.
- In some cases the data logging software used to record the instrument data did not use the same output as the reading displayed on the analyser – many instruments have both analogue and digital outputs. In this case the user should confirm that any quality checks and calibration adjustments are relevant to the data that is recorded.
- The instrument response time provides the user with data on the appropriate time between samples. In order to ensure that one reading is independent from the previous one it is recommended to leave more than $(3 \times T_{90})$ between readings, at which point one reading will have less than 0.1% influence on the next. If the time between readings is too short then this can lead to significant biases in the data.

3.2 Ducting Efficiency

These results show a much wider spread than seen for the methane analyser calibration results and, given that methane analyser effects have been allowed for, this must be due to a combination of sampling issues (such as inhomogeneous mixing), losses in the ducting and uncertainty in the chamber flow measurements.

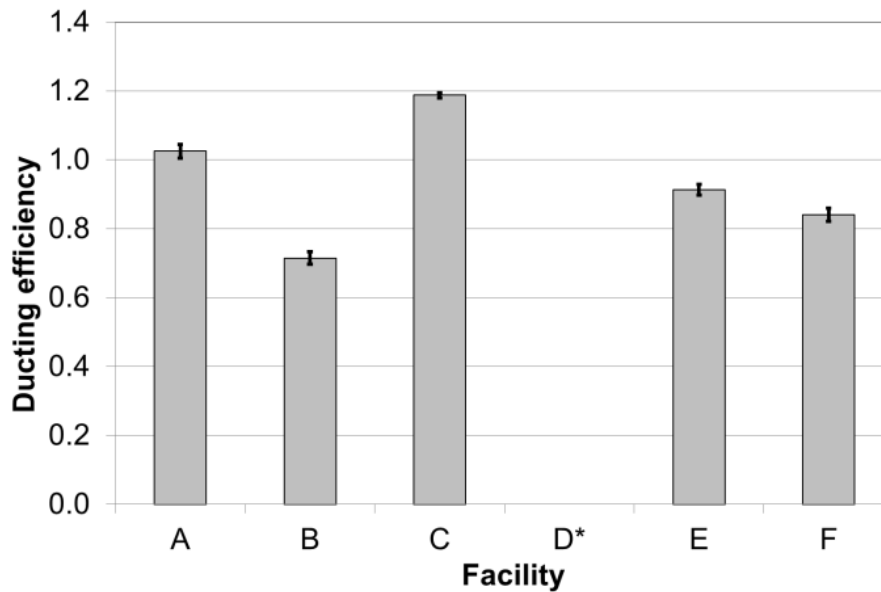

Figure 4 Ducting efficiency results. Columns give the efficiency values for the individual systems tested having corrected for the relevant sensor calibration factor, together with the ($k=2$, 95% confidence) uncertainties on the determination of the efficiencies. *Note that, due to facility design, it was not possible to determine the ducting efficiency result for facility D.

Chamber extracted air flow measurement presents a challenging issue, both in terms of calibration and adjustment to the ambient conditions at the time of measurement. If we assume the final methane emission rate is reported as a mass flow, then the chamber flow measurement also needs to be determined as a mass flow. Therefore, if the air flow measurements are actually a volume flow measurement, then an air density correction will be needed to convert to a final methane mass emission rate and this will require calibrated temperature and pressure (and potentially humidity) measurements to be made for the sample air at the point of the flow measurement. Whether this correction is needed comes down to the nature of the flow measurement method. In general terms, vane-based flow sensors measure the volume flow while hot-wire-based sensors measure the mass flow, but the details depend upon the exact nature of the sensor used. The location of the flow sensor within the duct can also influence the flow reading due to flow variation across the pipe diameter, as can

obstructions and bends in the pipework. All of these issues make validation of the chamber flow reading particularly difficult, and indirect validation through full system calibration using chamber recovery tests or more extensive experiments such as described here probably provide the most viable way of assessing the accuracy of the flow measurements.

3.3 Chamber Response

Figure 5 shows a typical response curve following the injection of a reference methane emission rate into the chamber, and Table 2 summarises the response results from all 6 facilities.

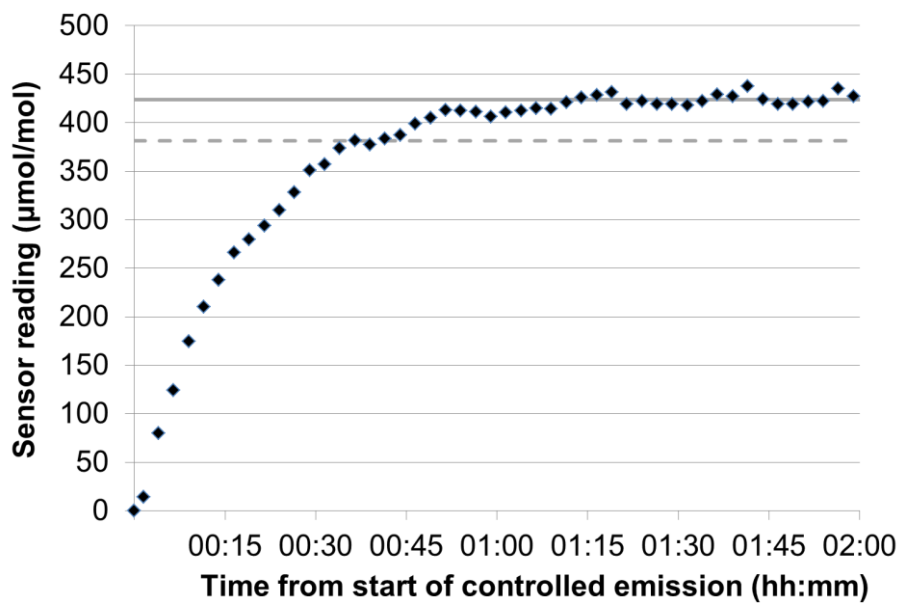

Figure 5 Response of facility to injection of a reference methane emission rate into chamber. Black diamonds show the measured response with time, the solid line shows the plateau reading level, and the dotted line shows the 90% value of plateau reading.

Facility	Plateau Stability	T ₉₀ Response (mm:ss)	Precision on 24 h average	Linearity (R ²)
A	1.33%	40:39'	0.39%	0.9996
B	1.63%	21:58	0.35%	0.9995
C	11.00%	01:13	0.55%	0.9981
D	4.27%	09:00	0.58%	0.9900
E	2.07%	27:42	0.50%	0.9971
F	2.70%	54:05	0.91%	0.9999

Table 2 Summary of Chamber Response Tests, giving for an example chamber at each facility : the variability on a stable reading, the T₉₀ response time, the measurement precision extrapolated to a 24 h average, and the R² linearity of response across the tested range.

Since the reference emission source is effectively constant during the measurements the plateau stability reflects the flow variability within the chamber and sampling ducts, and provides a measure of the precision of a single chamber measurement point. These results show much greater variability in both plateau stability and response time, with the slower response chambers showing better plateau stability. This is not unexpected as slower response chambers will tend to smooth out any short-term variation in the flow, and there is significant variation between chamber volume and air exchange flows which drives the chamber response times.

Another aspect of the chamber response times that should be considered is that they give information on the period over which an external disturbance could lead to incorrect readings, e.g. the chamber doors being opened and methane potentially escaping from the chamber. If the operator wishes to exclude data affected by known disturbances using one of the tests

presented in the paper then results should only start to be included once a period of three times the T_{90} response time has passed.

Although there are large differences in the precision of a single measurement, when we consider the precision on a 24 h average (4th column of Table 2) there is a much reduced spread. The 24 h precision value assumes a constant level of emission over the complete period. When the chambers are used for livestock measurements the emissions will be variable and depend on the experimental conditions (type of animals, feeding schedule, etc.). The measurement precision will lie somewhere between the short-term (plateau stability) and long-term (24 h precision) values. Note that this does not reflect the absolute accuracy of the measurements which is discussed in the following sections.

The final column of Table 2 shows the linearity of the chamber readings to varying levels of reference methane emissions. These values are slightly lower than those seen for the analysers themselves (see Table 1), but all show highly linear performance with R^2 values of 0.99 or higher for all chambers.

3.4 Chamber Capture Efficiency

As discussed above, the ducting efficiency was determined for an example chamber at all facilities except one (facility D). Figure 6 shows the ratio between the reference emission rate in a chamber against the measured value corrected using the respective facility analyser calibration function and ducting efficiency. Such correction removes any bias in concentration determination and / or flow measurement, isolating any differences from the reference value to the chamber itself. The result for facility D is the combined efficiency of the ducting and chamber.

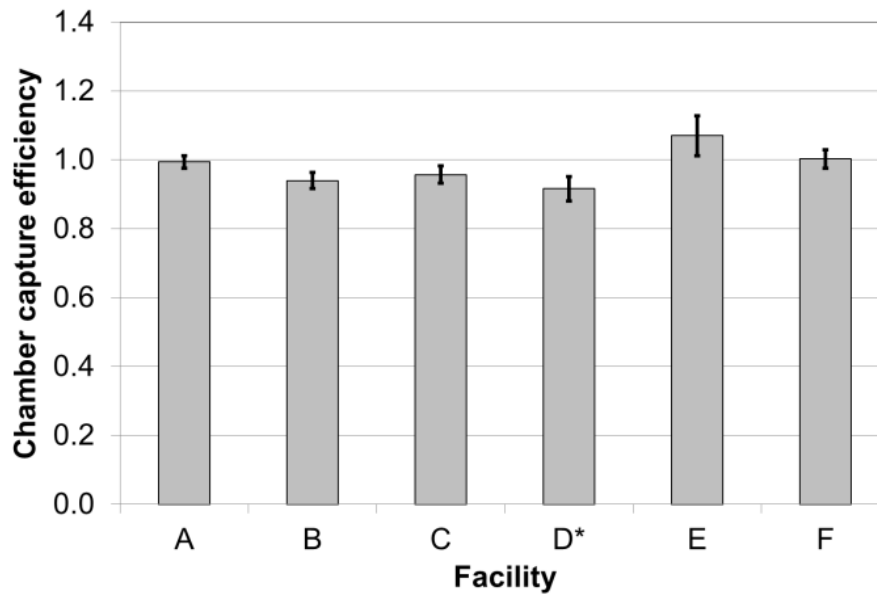

Figure 6 Chamber Capture Efficiencies. Columns give the efficiency values for the individual chambers tested together with the ($k=2$, 95% confidence) uncertainties on the determination of the efficiencies. *Note that for facility D the efficiency shown is the combined efficiency of the chamber capture and the ducting.

It can be seen that there are cases of both over- and under-estimation in the chamber capture results, so it is not just a case of methane leaks out of the chamber. Given that all facilities operate chambers at pressures slightly below atmospheric, leaks into the chamber are more likely than losses out. An inward leak of ambient air into the chamber should not cause a problem, as long as the air around the chamber has the same methane concentration as the main external air inlet. However, this may not always be the case depending on farm activity (e.g. nearby ruminants emitting methane).

Another effect which could cause the observed deviations is inhomogeneous mixing within the chamber and ducting. Some limited testing of source location dependence was carried out during the experiments. This showed that, in some chambers, the readings changed when the reference emission source was moved between different locations to simulate animal

movements, e.g. feeding or sleeping positions (changes of up to 17% were observed in one case). This indicates that the intake air and emission source gases are not well mixed at the point where a sample is extracted from the chamber for measurement. The dependence of the measured emission on source location would be an interesting topic for further investigation. This effect is one of a number of cases where the presence of an animal in the chamber could potentially influence the results. It was beyond the scope of this work to address this in detail, however the experiments described here establish the baseline chamber performance and the underpinning measurement uncertainty.

3.5 Combined facility results

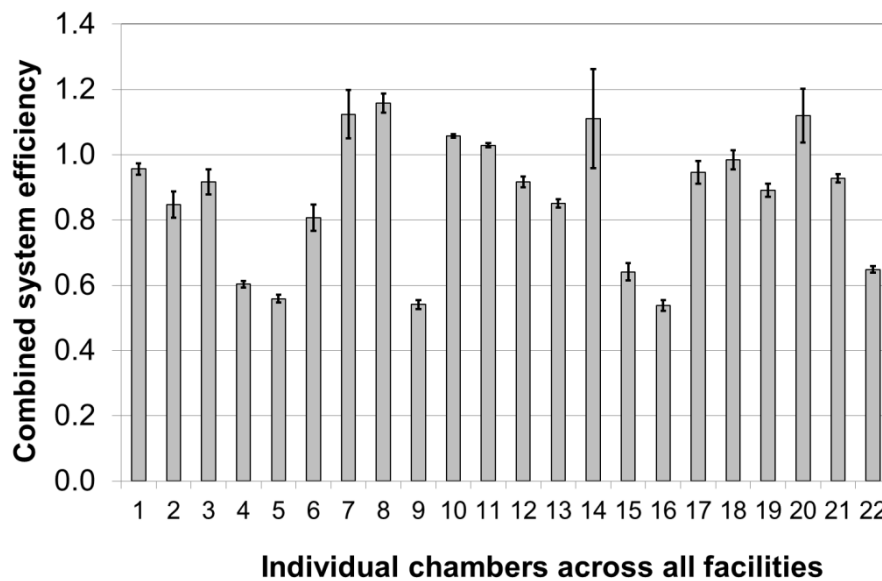

Figure 7 Individual combined system efficiencies. Columns give the combined values for the individual systems tested together with the ($k=2$, 95% confidence) uncertainties on the determination of the efficiencies.

Figure 7 shows the combined system efficiencies for every chamber tested across the six facilities, i.e. a single value combining any bias found in analyser calibration, ducting efficiency and chamber capture efficiency, together with error bars showing the associated

($k=2$, 95% confidence level) uncertainty on each efficiency. The differences in the size of the error bars is mainly driven by the variability in the readings for different chamber designs (as indicated by the plateau stabilities in Table 2). As can be seen the spread in combined system efficiencies across all the chambers is marked. An important question is whether this variability is due to chamber-to-chamber differences within facilities or facility-to-facility differences. Therefore, it is useful to determine the overall facility efficiencies shown in Table 3.

Facility	Combined system efficiency	Uncertainty ($k=2$)
A	1.045	0.004
B	0.590	0.005
C	1.154	0.030
D	0.827	0.028
E	0.945	0.013
F	0.897	0.008

Table 3 Combined Facility system efficiencies, giving the combined efficiencies across all chambers at each facility, together with the ($k=2$, 95% confidence) uncertainty on the derivation of each efficiency.

These data demonstrate that the inter-facility variance is of similar magnitude to that between individual chambers. This result shows that the facility design and operation is the largest source of absolute uncertainty rather than chamber-to-chamber variability or instrumental noise. This result also confirms the suitability of each facility to carry out relative measurements, e.g. to compare the effectiveness of different treatments, but highlights the

importance of this type of validation exercise in evaluating absolute uncertainties and establishing comparability between different facilities.

Combined efficiencies	Mean	1σ Spread
Complete facility	0.9097	19.4%
Methane analyser	1.001	2.4%
Ducting incl. flow	0.9308	19.8%
Chamber only	0.9849	4.0%

Combined efficiencies	Mean	1σ Spread
Complete facility	0.9736	12.8%
Methane analyser	0.992	1.3%
Ducting incl. flow	0.9968	15.3%
Chamber only	0.9971	3.4%

Table 4 Chamber Performance Summary, showing the mean efficiencies across the facilities and the (1σ) spread of values. The results are given for the combined facilities, and separately for the three main elements in each facility (analyser, ducting and flow, chamber). The upper table includes all chamber facilities, the lower table excludes the new, untested facility (facility B).

Table 4 shows a measure of overall capability for the facilities evaluated by taking the mean of the individual facility efficiencies and providing the 1σ spread (a measure of the variability between the results for the different facilities) in these values. Table 4 also shows the mean and spread values for the three main components of a chamber facility – the analyser, the ducting and flow system, and the chamber itself. These results highlight that it is

the ducting and flow system that is the main source of variability in the different combined facility results.

The upper and lower panels of Table 4 shows these values with and without including data from facility B, as this was a new facility which had undergone no quality assurance testing prior to these measurements (and therefore had no prior influence in determining UK livestock emissions). The validation tests on facility B revealed a significant issue with the design which has since been rectified, and results from this facility are therefore excluded from the following general discussion.

The final aspect of the work was to assess the difference the validation exercise had on the overall capability across all the facilities tested by considering how the combined uncertainty has changed. The combined uncertainty is made up of both bias sources (e.g. ducting efficiency) and random sources (e.g. noise associated with methane analyser). The significant bias sources for each facility are all incorporated into the combined system efficiencies. Random uncertainty sources such as methane analyser noise, flow meter noise, etc. are incorporated into the 24 h precision values shown in Table 2.

Prior to the validation exercise the bias terms were unknown, and the combined uncertainty would be dominated by these terms. The distribution of combined system efficiencies can therefore be used to give an estimate of the combined uncertainty associated with the overall capability across all facilities of 25.7% ($k=2$, 95% confidence).

Following the validation exercise, if each facility corrects for the combined system efficiency in future measurements then in principle the aforementioned bias uncertainty

sources are removed leaving only random sources (i.e. determined in the 24 h precision test) and the uncertainties associated with the determination of the efficiencies. Hence, the combined uncertainty estimate decreases to 2.1% ($k=2$, 95% confidence). It should be noted that this makes the critical assumption that all the facilities remain unchanged from the time the validation exercise was carried out, which is unlikely. However, whilst effects such as drift will result in an uncertainty increase from that above, it would require a very substantial facility change before values of 25.7% are approached. This notwithstanding, if a regime was put in place to repeat some of the measurements on a periodical basis this would ensure the combined uncertainty remains close to the 2.1% estimate.

4. Conclusions

The coordinated set of chamber validation experiments described here has established the absolute accuracy of the methane emission rates measured by the respiration chambers, and for the first time provides metrological traceability to international standards, assesses the impact of both analyser and chamber response times on measurement uncertainty and establishes direct comparability between measurements made across different facilities with a wide range of chamber designs.

As a result of the validation exercise the estimated combined uncertainty associated with the overall capability across all facilities reduced from 25.7% ($k=2$, 95% confidence) before the validation to 2.1% ($k=2$, 95% confidence) when the efficiency corrections are applied to the results. The results show that the measurement uncertainty prior to validation is dominated by uncertainties in the sample ducting and flow measurement.

The work demonstrates the importance of validating national measurement infrastructure against traceable references and the potential value that can be added to future measurements as a result, particularly when looking to determine absolute methane emission values and when combining results from different facilities.

5. Acknowledgements

The authors would like to thank Elena Amico di Meane, Marta Doval Minarro and Ian Uprichard from the Gas and Particle Metrology Group at NPL for the calibration of the mass flow controllers and preparation of the reference methane standards, and acknowledge the invaluable support during the field campaigns from the researchers and technical support teams at each chamber facility.

This work was funded by DEFRA, the Scottish Government, Department of Agriculture and Rural Development (N.I.), and the Welsh Government as part of the UK's Agricultural GHG Research Platform project (www.ghgplatform.org.uk). The underpinning metrology was supported by the National Measurement System's Chem-Bio Knowledge Base programme under the Environmental Technologies theme.

6. References

1. IPCC (2013) Climate Change 2013: The Physical Science Basis. Contribution of Working Group I to the Fifth Assessment Report of the Intergovernmental Panel on Climate Change. Stocker TF, Qin D, Plattner GK, Tignor M, Allen SK, Boschung J, Nauels A, Xia Y, Bex V and Migley PM (eds.). Cambridge University Press, United Kingdom and New York, NY, USA, 1355 pp.

2. European Environment Agency (2013) Trends and projections in Europe 2013 – Tracking progress towards Europe's climate and energy targets until 2020. EEA Report No 10/2013.
3. IPCC (2006) 2006 IPCC Guidelines for National Greenhouse Gas Inventories, Prepared by the National Greenhouse Gas Inventories Programme, Eggleston H.S., Buendia L., Miwa K., Ngara T. and Tanabe K. (eds). Published: IGES, Japan.
4. <http://www.ghgplatform.org.uk/> accessed May 2014.
5. Grainger C, Clarke T, McGinn SM, Auldish MJ, Beauchemin KA, Hannah MC, Waghorn GC, Clarke H, Eckard RJ (2007) Methane emissions from dairy cows measured using the sulphur hexafluoride (SF₆) tracer and chamber techniques. *J. Dairy Sci.* 90:2755-2766.
6. Armsby, HP (1908) *The Principles of Animal Nutrition*. John Wiley and Sons, New York, NY, USA.
7. Cammell, SB, Beaver DE, Skelton KV, Spooner MC (1981) The construction of open-circuit calorimeters for measuring the gaseous exchange and heat production in sheep and young cattle. *Laboratory Practice* 30:115-121.
8. McLean JA, Tobin G (1987) *Animal and Human Calorimetry*. Cambridge University Press, Cambridge, UK.
9. Derno M, Elsner HG, Paetow EA, Scholze H, Schweigel M (2009) Technical Note : A new facility for continuous respiration measurements in lactating cows. *J. Dairy Sci.* 92:2804-2808.
10. Murray PJ, Moss A, Lockyer DR, Jarvis SC (1999) A comparison of systems for measuring methane emissions from sheep. *J. Agric. Sci.* 133(Pt4):439-444.
11. Klein L, Wright ADG (2006) Construction and operation of open-circuit methane chambers for small ruminants. *Aust. J. Exp. Agric.* 46:1257-1262.

12. Pinares C, Waghorn G (Eds) (2012) Technical manual on respiration chamber designs. Ministry of Agriculture and Forest, Wellington, New Zealand. Accessed Feb 11, 2014. <http://globalresearchalliance.org/app/uploads/2012/03/GRA-MAN-Facility-BestPract-2012-ch1.pdf> and related links.
13. Hellwing ALF, Lund P, Weisberg MR, Brask M, Hvelplund T, 2012. Technical Note : Test of a low-cost and animal friendly system for measuring methane emissions from dairy cows. *J. Dairy Sci.* 95:6077-6085.
14. <http://kcdb.bipm.org/> accessed May 2014.
15. http://kcdb.bipm.org/appendixc/qm/GB/qm_gb_4.pdf accessed May 2014.
16. EN 15267-3: 2007. European Standard : Air quality, Certification of automated measuring systems. Performance criteria and test procedures for automated measuring systems for monitoring emissions from stationary sources.